

**BENTLEY**  
RESIDENCES

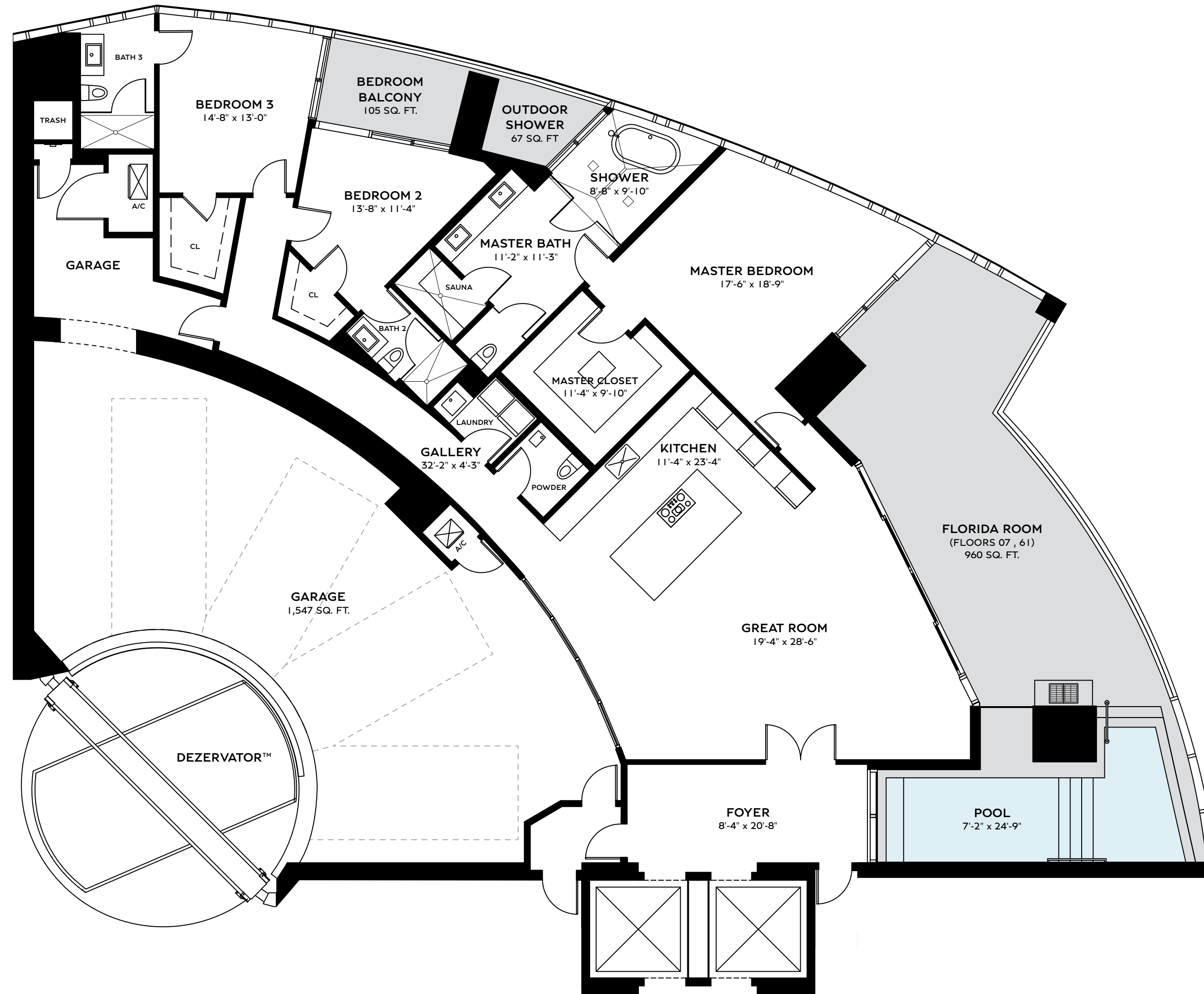

**RESIDENCE ARRANGE**  
**3 BEDS | 3.5 BATHS**  
 FLOORS 07 , 61

INTERIOR	3,015 SQ. FT.	280.10 SQ. M.
BALCONY	1,132 SQ. FT.	105.17 SQ. M.
GARAGE	1,547 SQ. FT.	143.72 SQ. M.
<b>TOTAL</b>	<b>5,694 SQ. FT.</b>	<b>528.99 SQ. M.</b>

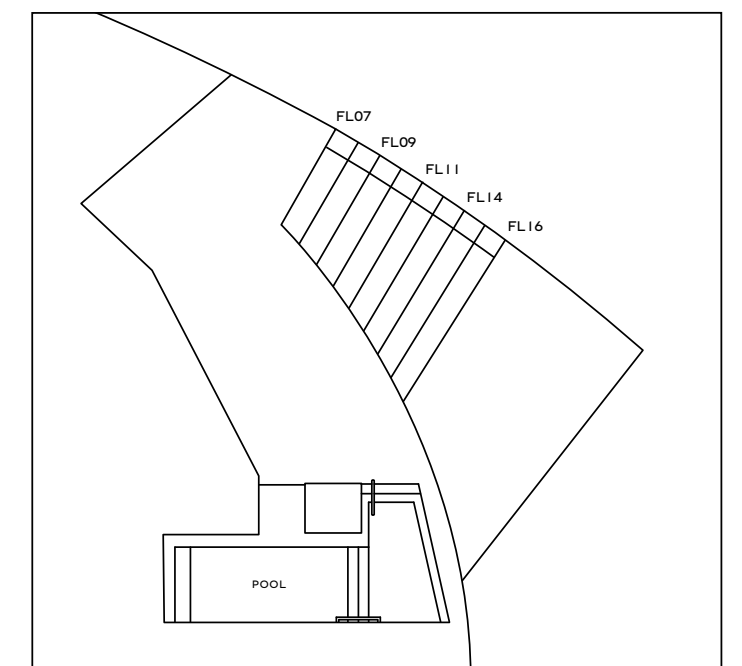
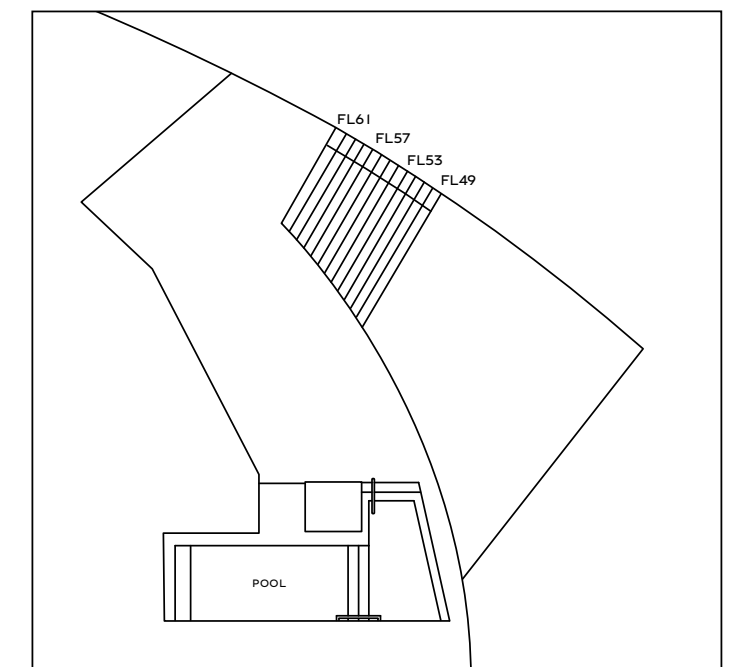

TERRACE AREA VARIES BY FLOOR

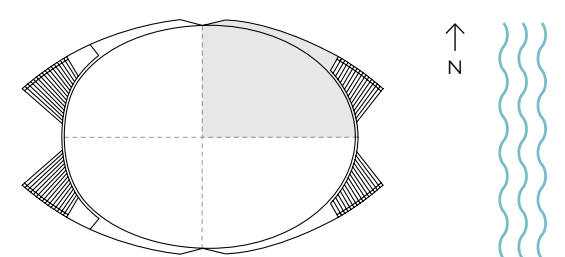

ORAL REPRESENTATIONS CANNOT BE RELIED UPON AS CORRECTLY STATING THE REPRESENTATIONS OF THE DEVELOPER. FOR CORRECT REPRESENTATIONS, MAKE REFERENCE TO THIS BROCHURE AND TO THE DOCUMENTS REQUIRED BY SECTION 718.503, FLORIDA STATUTES, TO BE FURNISHED BY A DEVELOPER TO A BUYER OR LESSEE. Stated dimensions are measured to the exterior boundaries of the exterior walls and the centerline of interior demising walls and in fact vary from the dimensions that would be determined by using the description and definition of the "Unit" set forth in the Declaration (which generally only includes the interior airspace between the perimeter walls and excludes interior structural components). For your reference, the area of the Unit, determined in accordance with those defined unit boundaries, is described on Exhibit 3 to the Declaration. Note that measurements of rooms set forth on this floor plan are generally taken at the greatest points of each given room (as if the room were a perfect rectangle), without regard for any cutouts. Accordingly, the area of the actual room will typically be smaller than the product obtained by multiplying the stated length times width. All dimensions are approximate and may vary with actual construction, and all floor plans and development plans are subject to change. The name 'Bentley' is a registered trademark. © 2022 Bentley Residences.



Sales Gallery: 18325 Collins Avenue, Sunny Isles Beach, FL 33160  
Tel 305 BENTLEY (305 236 8539) [bentleyresidencesmiami.com](http://bentleyresidencesmiami.com)

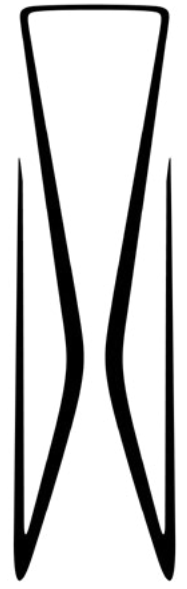

**BENTLEY**  
RESIDENCES

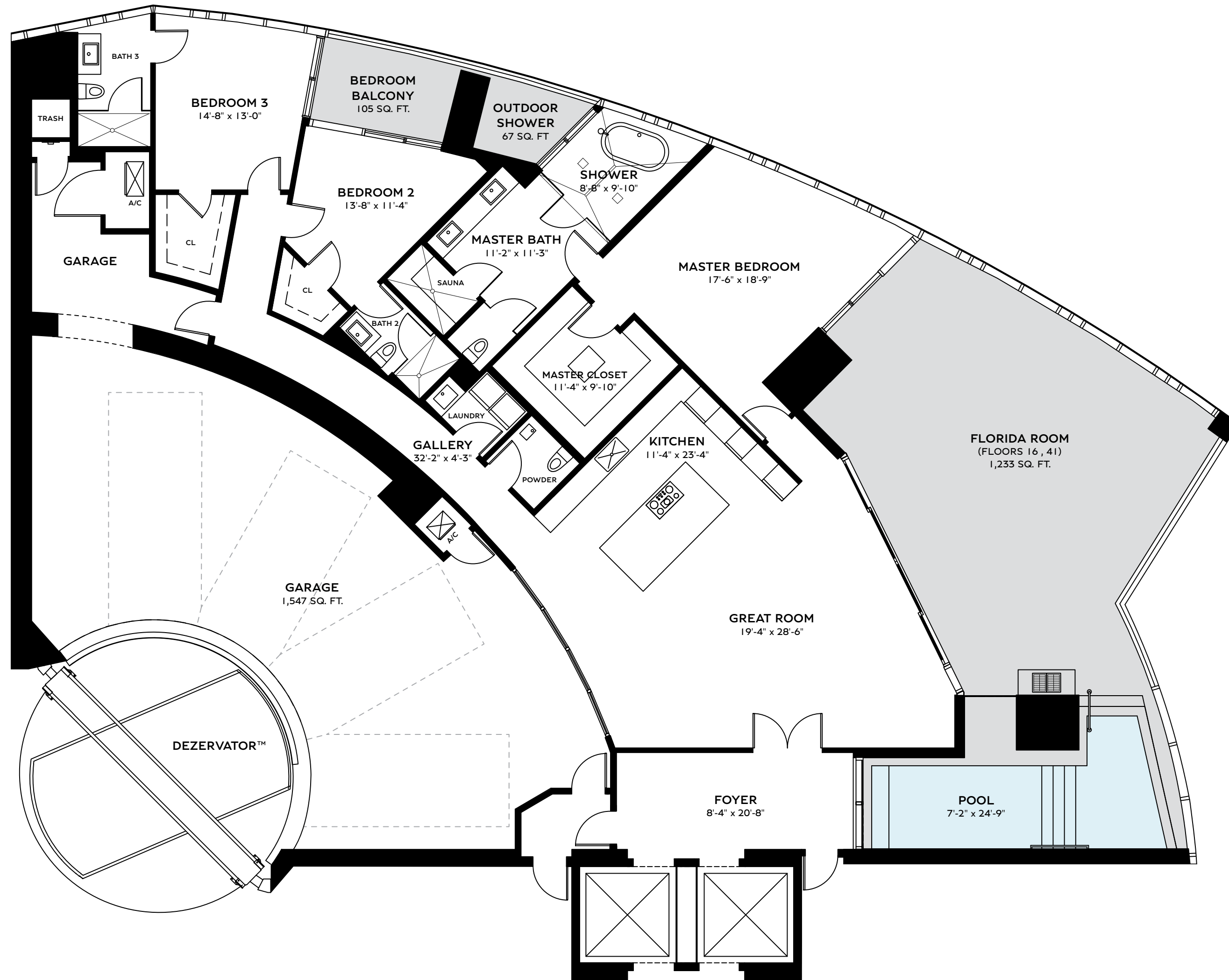

**RESIDENCE ARRANGE**  
**3 BEDS | 3.5 BATHS**  
FLOORS 16, 41

INTERIOR	3,015 SQ. FT.	280.10 SQ. M.
BALCONY	1,405 SQ. FT.	130.53 SQ. M.
GARAGE	1,547 SQ. FT.	143.72 SQ. M.
<b>TOTAL</b>	<b>5,967 SQ. FT.</b>	<b>554.35 SQ. M.</b>

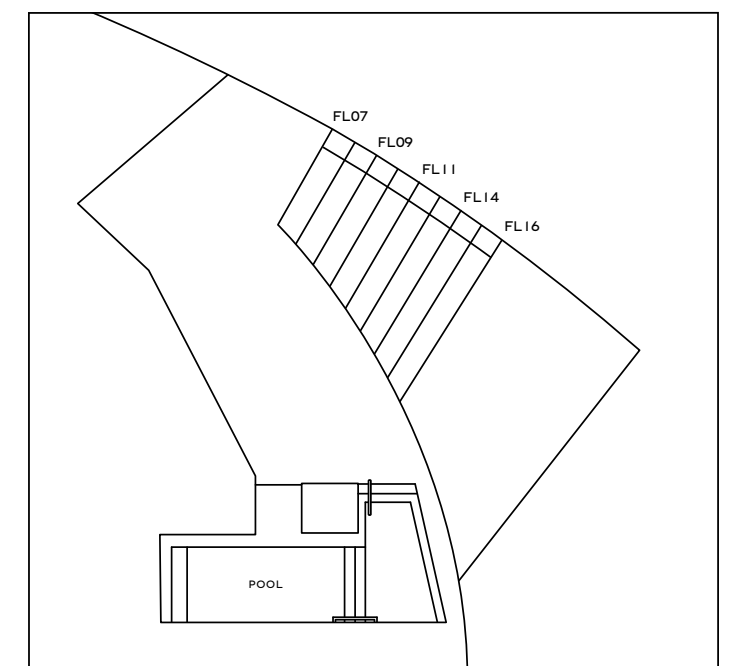
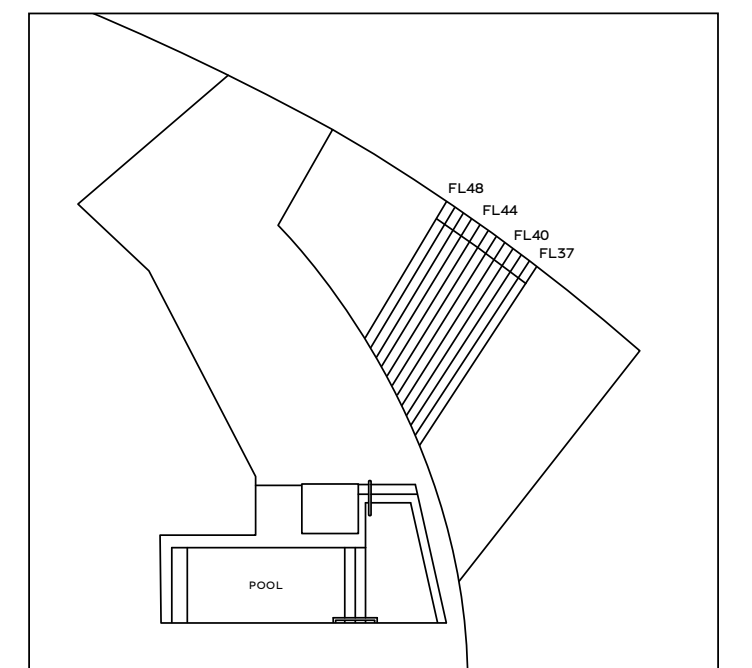

TERRACE AREA VARIES BY FLOOR

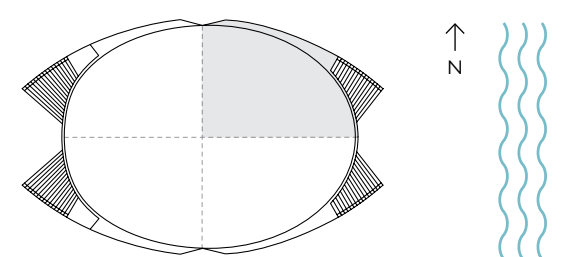

ORAL REPRESENTATIONS CANNOT BE RELIED UPON AS CORRECTLY STATING THE REPRESENTATIONS OF THE DEVELOPER. FOR CORRECT REPRESENTATIONS, MAKE REFERENCE TO THIS BROCHURE AND TO THE DOCUMENTS REQUIRED BY SECTION 718.503, FLORIDA STATUTES, TO BE FURNISHED BY A DEVELOPER TO A BUYER OR LESSEE. Stated dimensions are measured to the exterior boundaries of the exterior walls and the centerline of interior demising walls and in fact vary from the dimensions that would be determined by using the description and definition of the "Unit" set forth in the Declaration (which generally only includes the interior airspace between the perimeter walls and excludes interior structural components). For your reference, the area of the Unit, determined in accordance with those defined unit boundaries, is described on Exhibit 3 to the Declaration. Note that measurements of rooms set forth on this floor plan are generally taken at the greatest points of each given room (as if the room were a perfect rectangle), without regard for any cutouts. Accordingly, the area of the actual room will typically be smaller than the product obtained by multiplying the stated length times width. All dimensions are approximate and may vary with actual construction, and all floor plans and development plans are subject to change. The name 'Bentley' is a registered trademark. © 2022 Bentley Residences.



Sales Gallery: 18325 Collins Avenue, Sunny Isles Beach, FL 33160  
Tel 305 BENTLEY (305 236 8539) [bentleyresidencesmiami.com](http://bentleyresidencesmiami.com)

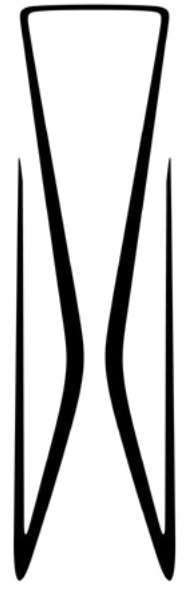

**BENTLEY**  
RESIDENCES

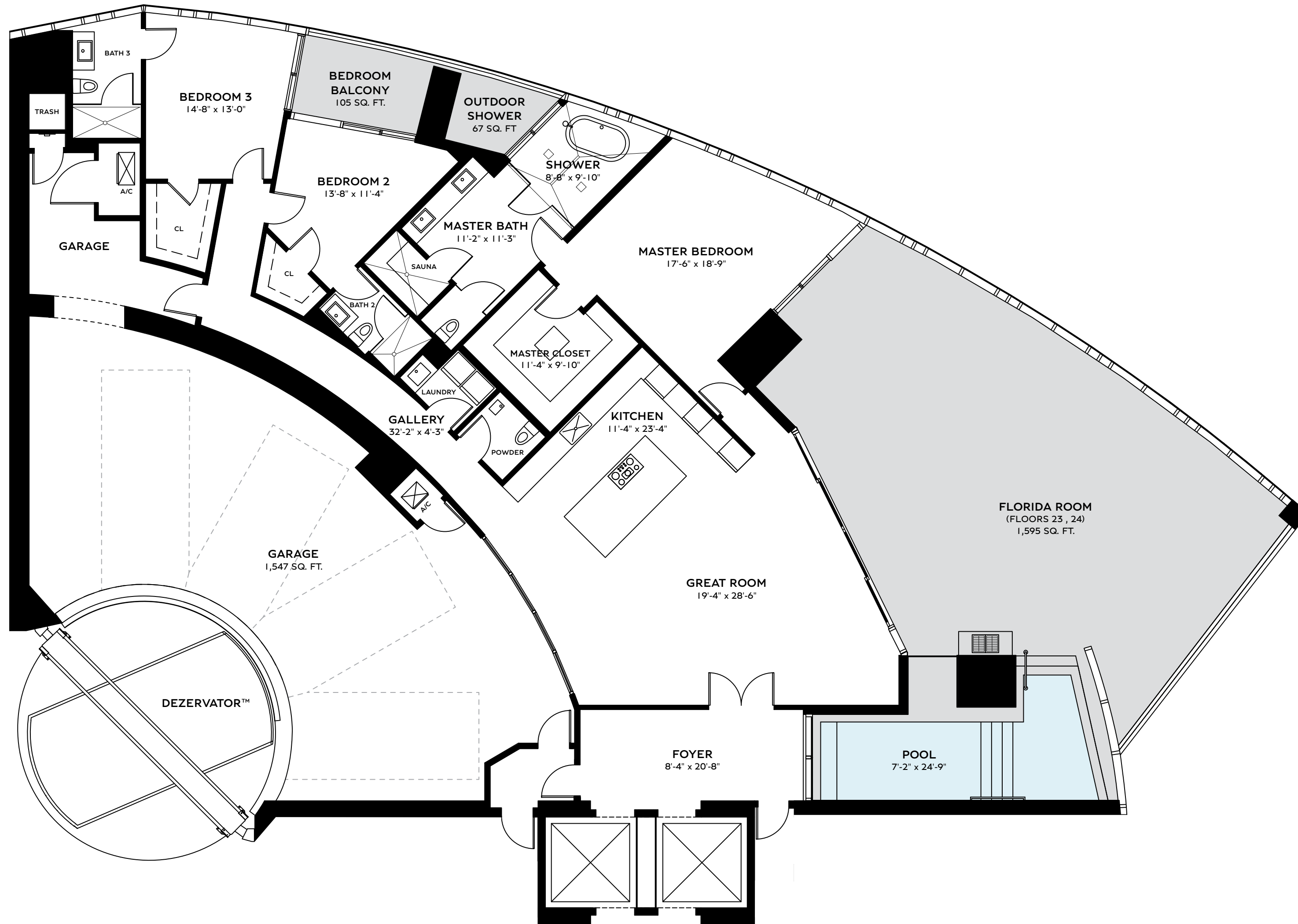

**RESIDENCE ARNAGE**  
3 BEDS | 3.5 BATHS  
FLOORS 23, 24

INTERIOR	3,015 SQ. FT.	280.10 SQ. M.
BALCONY	1,767 SQ. FT.	164.16 SQ. M.
GARAGE	1,547 SQ. FT.	143.72 SQ. M.
<b>TOTAL</b>	<b>6,329 SQ. FT.</b>	<b>587.98 SQ. M.</b>

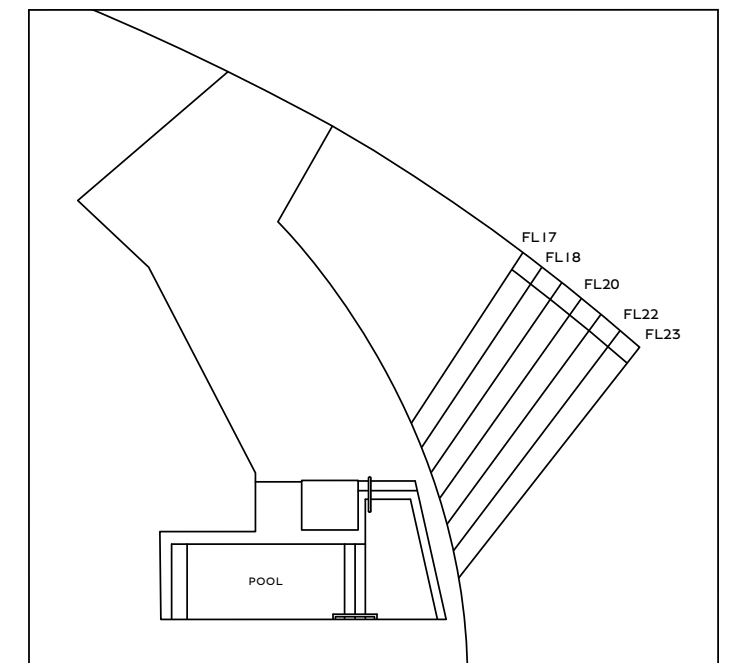
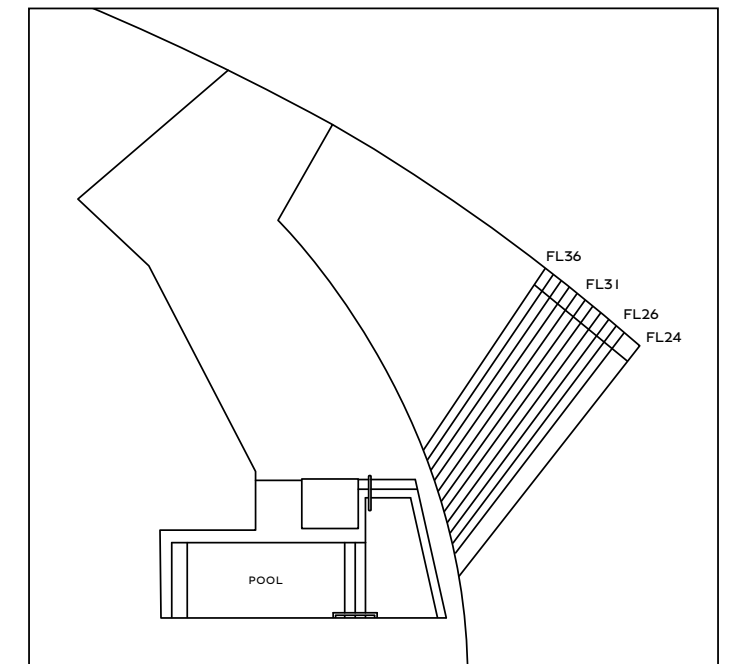

TERRACE AREA VARIES BY FLOOR

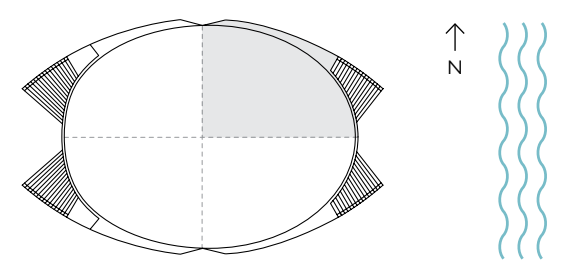

ORAL REPRESENTATIONS CANNOT BE RELIED UPON AS CORRECTLY STATING THE REPRESENTATIONS OF THE DEVELOPER. FOR CORRECT REPRESENTATIONS, MAKE REFERENCE TO THIS BROCHURE AND TO THE DOCUMENTS REQUIRED BY SECTION 718.503, FLORIDA STATUTES, TO BE FURNISHED BY A DEVELOPER TO A BUYER OR LESSEE. Stated dimensions are measured to the exterior boundaries of the exterior walls and the centerline of interior demising walls and in fact vary from the dimensions that would be determined by using the description and definition of the "Unit" set forth in the Declaration (which generally only includes the interior airspace between the perimeter walls and excludes interior structural components). For your reference, the area of the Unit, determined in accordance with those defined unit boundaries, is described on Exhibit 3 to the Declaration. Note that measurements of rooms set forth on this floor plan are generally taken at the greatest points of each given room (as if the room were a perfect rectangle), without regard for any cutouts. Accordingly, the area of the actual room will typically be smaller than the product obtained by multiplying the stated length times width. All dimensions are approximate and may vary with actual construction, and all floor plans and development plans are subject to change. The name 'Bentley' is a registered trademark. © 2022 Bentley Residences.



Sales Gallery: 18325 Collins Avenue, Sunny Isles Beach, FL 33160  
Tel 305 BENTLEY (305 236 8539) [bentleyresidencesmiami.com](http://bentleyresidencesmiami.com)

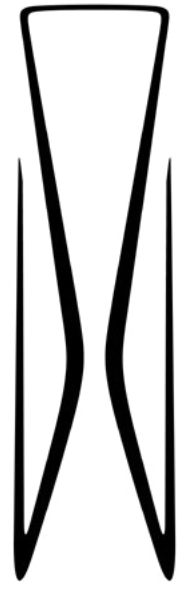

**BENTLEY**  
RESIDENCES

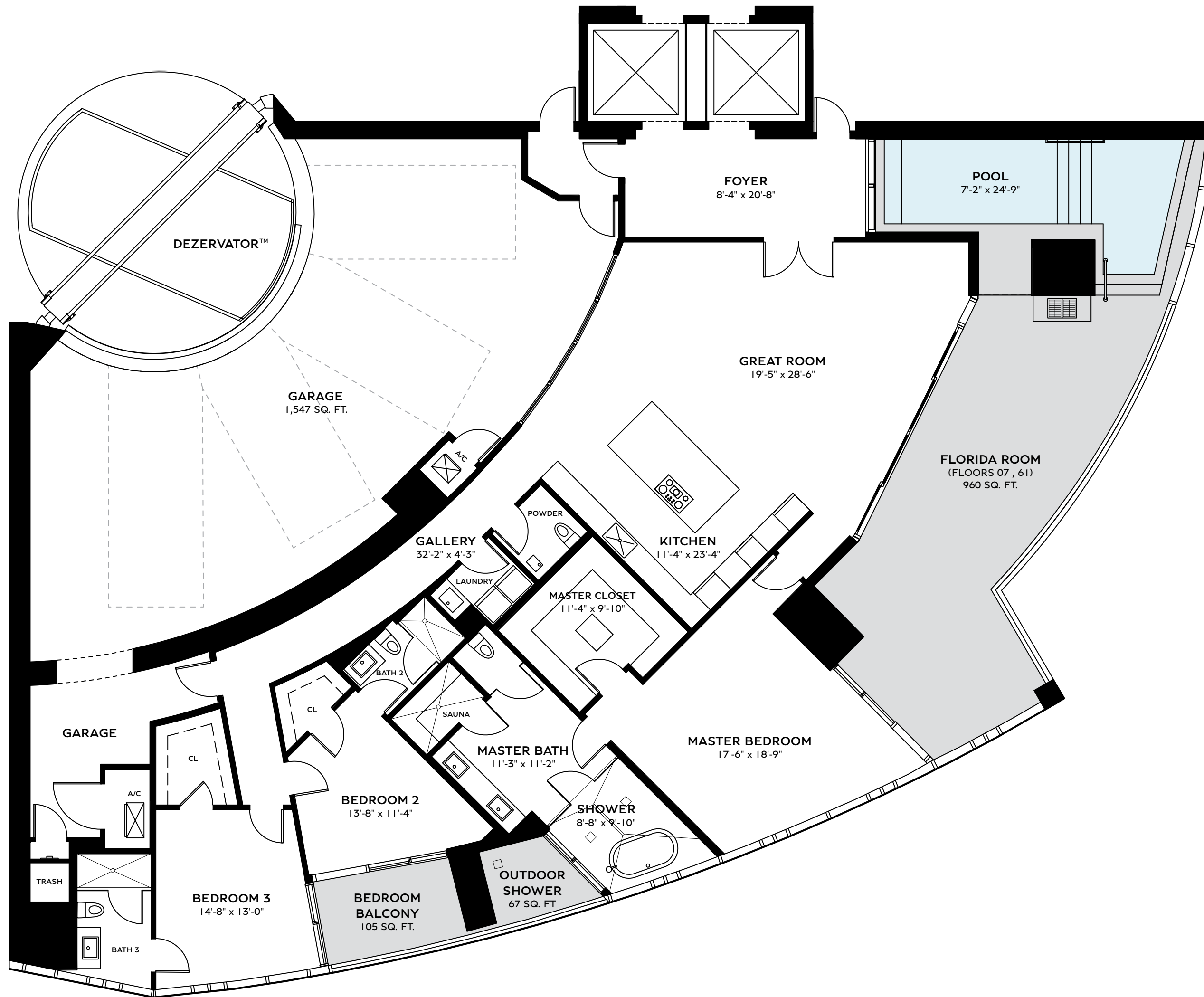

**RESIDENCE AZURE**  
**3 BEDS | 3.5 BATHS**

FLOORS 07 , 61

INTERIOR	3,015 SQ. FT.	280.10 SQ. M.
BALCONY	1,132 SQ. FT.	105.17 SQ. M.
GARAGE	1,547 SQ. FT.	143.72 SQ. M.
<b>TOTAL</b>	<b>5,694 SQ. FT.</b>	<b>528.99 SQ. M.</b>

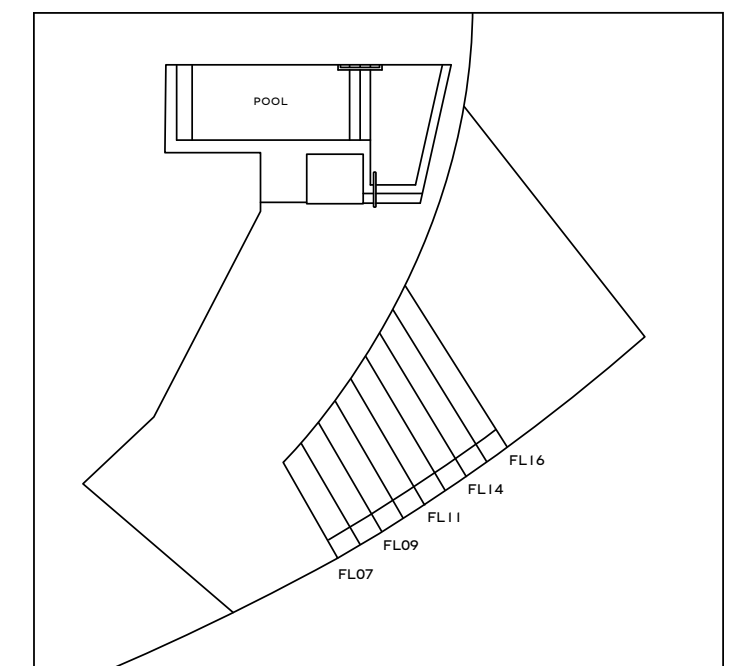
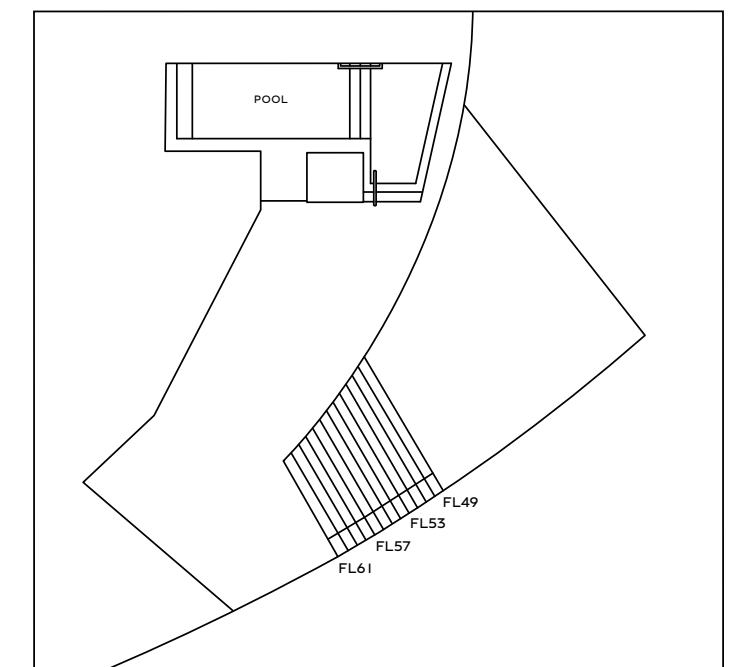

TERRACE AREA VARIES BY FLOOR

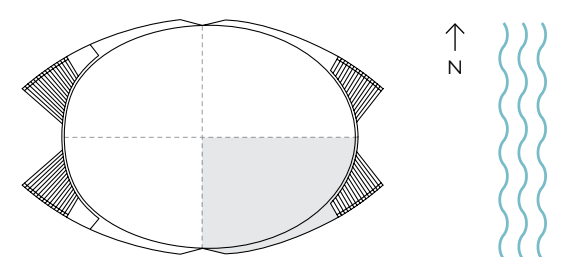

ORAL REPRESENTATIONS CANNOT BE RELIED UPON AS CORRECTLY STATING THE REPRESENTATIONS OF THE DEVELOPER. FOR CORRECT REPRESENTATIONS, MAKE REFERENCE TO THIS BROCHURE AND TO THE DOCUMENTS REQUIRED BY SECTION 718.503, FLORIDA STATUTES, TO BE FURNISHED BY A DEVELOPER TO A BUYER OR LESSEE. Stated dimensions are measured to the exterior boundaries of the exterior walls and the centerline of interior demising walls and in fact vary from the dimensions that would be determined by using the description and definition of the "Unit" set forth in the Declaration (which generally only includes the interior airspace between the perimeter walls and excludes interior structural components). For your reference, the area of the Unit, determined in accordance with those defined unit boundaries, is described on Exhibit 3 to the Declaration. Note that measurements of rooms set forth on this floor plan are generally taken at the greatest points of each given room (as if the room were a perfect rectangle), without regard for any cutouts. Accordingly, the area of the actual room will typically be smaller than the product obtained by multiplying the stated length times width. All dimensions are approximate and may vary with actual construction, and all floor plans and development plans are subject to change. The name 'Bentley' is a registered trademark. © 2022 Bentley Residences.



Sales Gallery: 18325 Collins Avenue, Sunny Isles Beach, FL 33160  
Tel 305 BENTLEY (305 236 8539) [bentleyresidencesmiami.com](http://bentleyresidencesmiami.com)

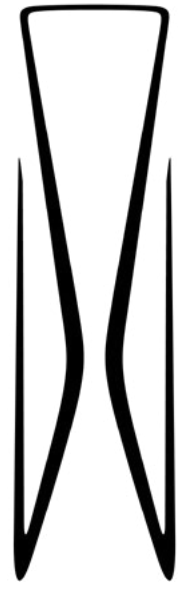

**B**  
BENTLEY  
RESIDENCES

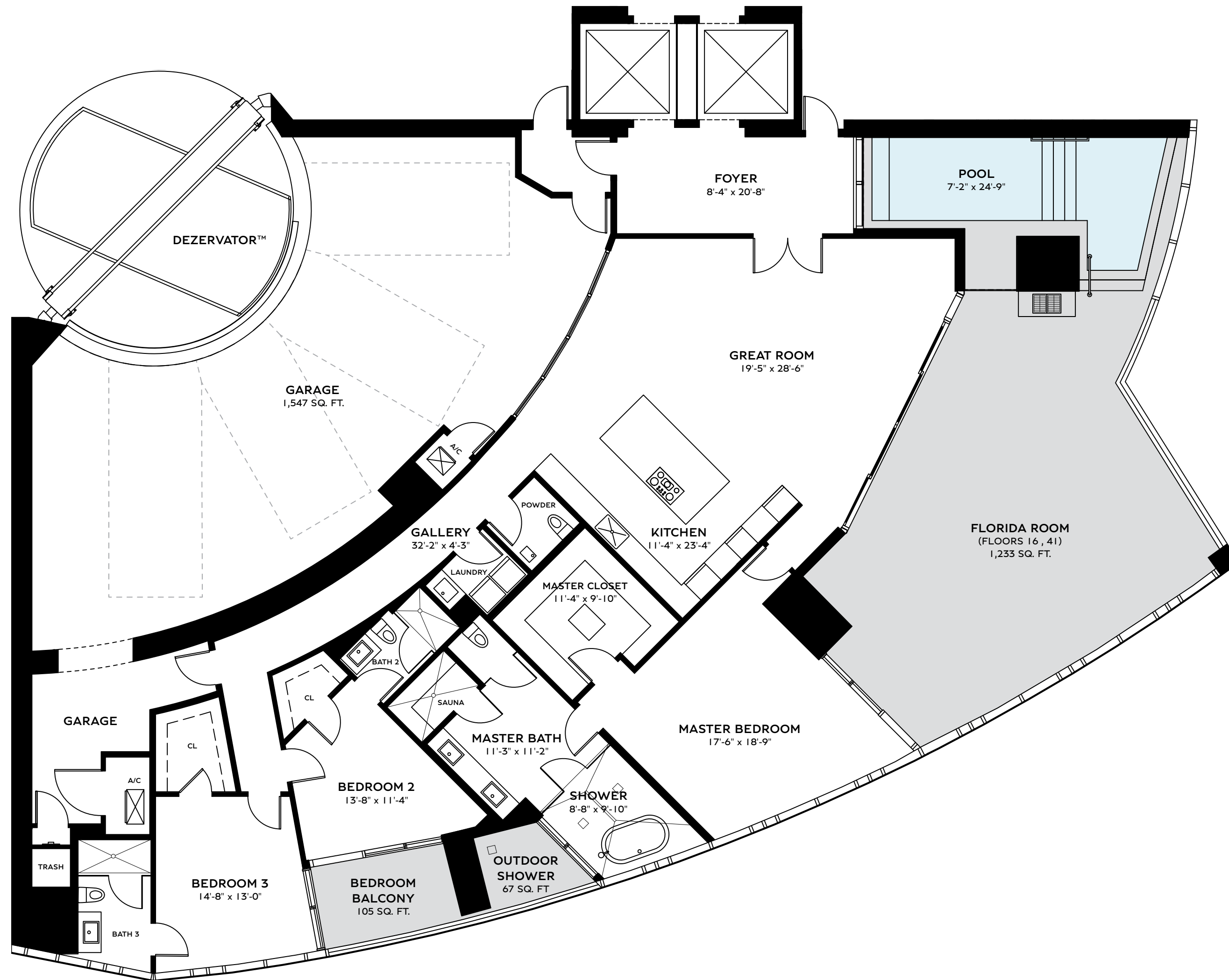

**RESIDENCE AZURE**  
**3 BEDS | 3.5 BATHS**

FLOORS 16, 41

INTERIOR	3,015 SQ. FT.	280.10 SQ. M.
BALCONY	1,405 SQ. FT.	130.53 SQ. M.
GARAGE	1,547 SQ. FT.	143.72 SQ. M.
<b>TOTAL</b>	<b>5,967 SQ. FT.</b>	<b>554.35 SQ. M.</b>

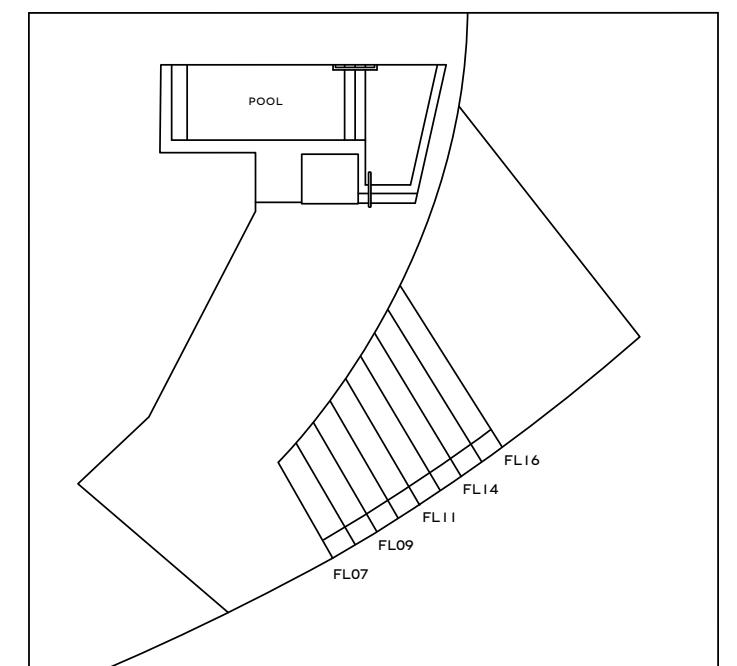
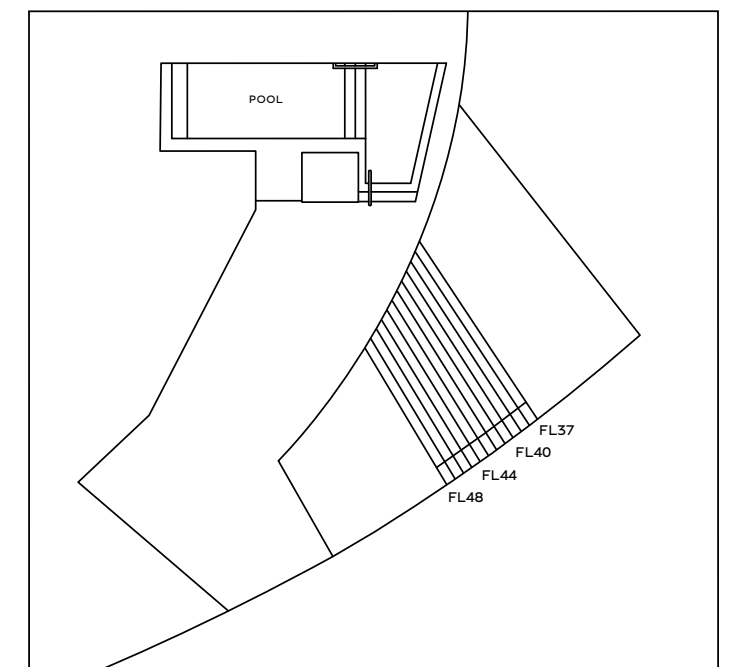

TERRACE AREA VARIES BY FLOOR

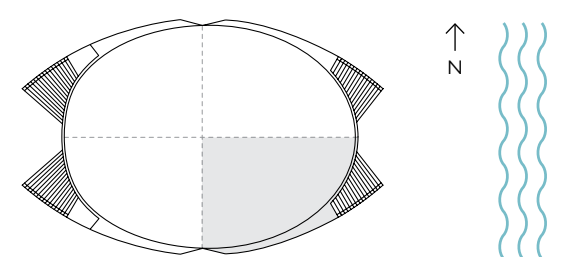

ORAL REPRESENTATIONS CANNOT BE RELIED UPON AS CORRECTLY STATING THE REPRESENTATIONS OF THE DEVELOPER. FOR CORRECT REPRESENTATIONS, MAKE REFERENCE TO THIS BROCHURE AND TO THE DOCUMENTS REQUIRED BY SECTION 718.503, FLORIDA STATUTES, TO BE FURNISHED BY A DEVELOPER TO A BUYER OR LESSEE. Stated dimensions are measured to the exterior boundaries of the exterior walls and the centerline of interior demising walls and in fact vary from the dimensions that would be determined by using the description and definition of the "Unit" set forth in the Declaration (which generally only includes the interior airspace between the perimeter walls and excludes interior structural components). For your reference, the area of the Unit, determined in accordance with those defined unit boundaries, is described on Exhibit 3 to the Declaration. Note that measurements of rooms set forth on this floor plan are generally taken at the greatest points of each given room (as if the room were a perfect rectangle), without regard for any cutouts. Accordingly, the area of the actual room will typically be smaller than the product obtained by multiplying the stated length times width. All dimensions are approximate and may vary with actual construction, and all floor plans and development plans are subject to change. The name 'Bentley' is a registered trademark. © 2022 Bentley Residences.



Sales Gallery: 18325 Collins Avenue, Sunny Isles Beach, FL 33160  
Tel 305 BENTLEY (305 236 8539) [bentleyresidencesmiami.com](http://bentleyresidencesmiami.com)



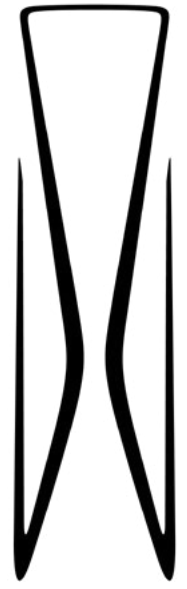

**B**  
BENTLEY  
RESIDENCES

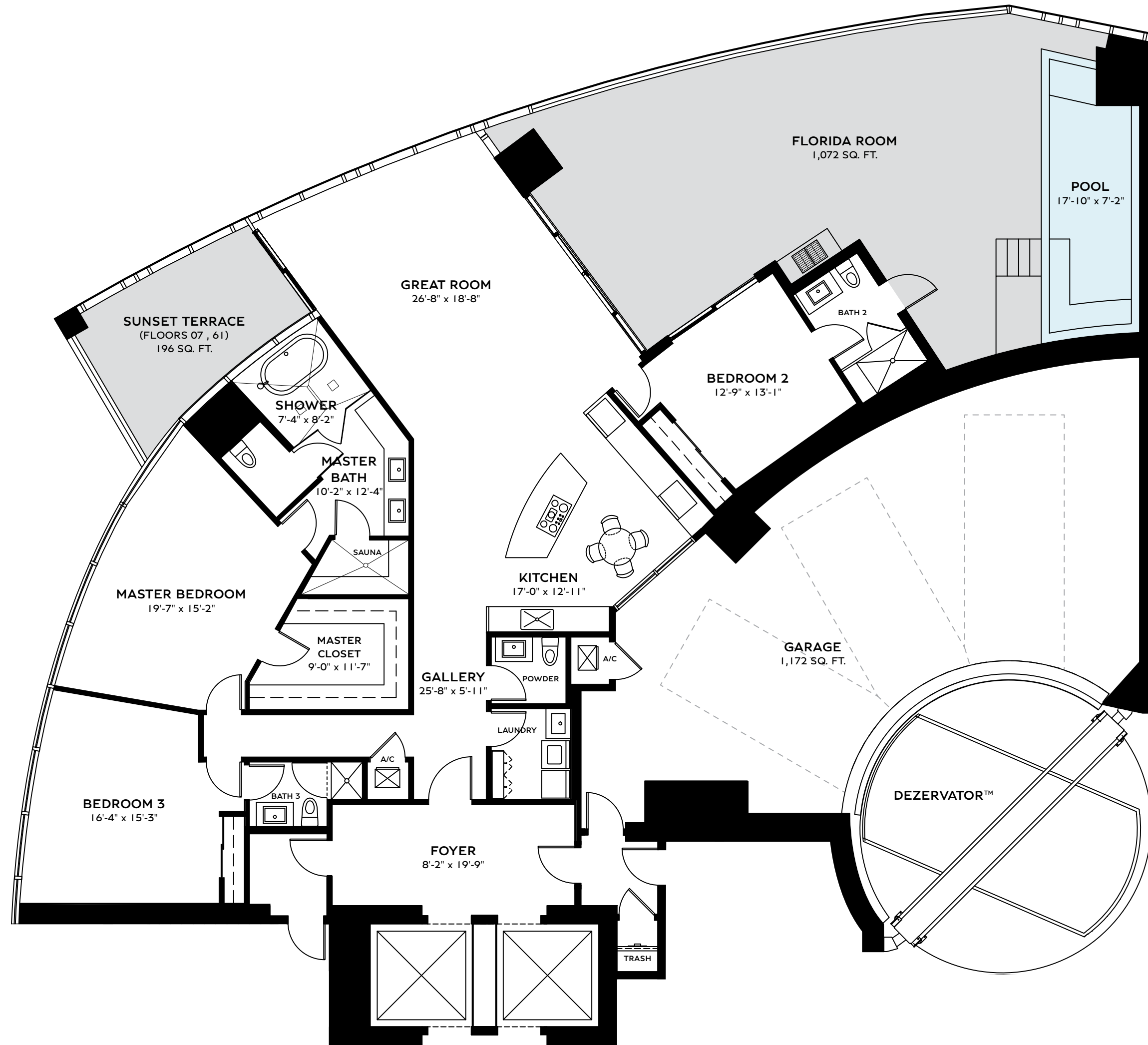

**RESIDENCE BACALAR**  
3 BEDS | 3.5 BATHS  
FLOORS 07, 61

INTERIOR	2,835 SQ. FT.	263.38 SQ. M.
BALCONY	1,268 SQ. FT.	117.80 SQ. M.
GARAGE	1,172 SQ. FT.	108.88 SQ. M.
<b>TOTAL</b>	<b>5,275 SQ. FT.</b>	<b>490.06 SQ. M.</b>

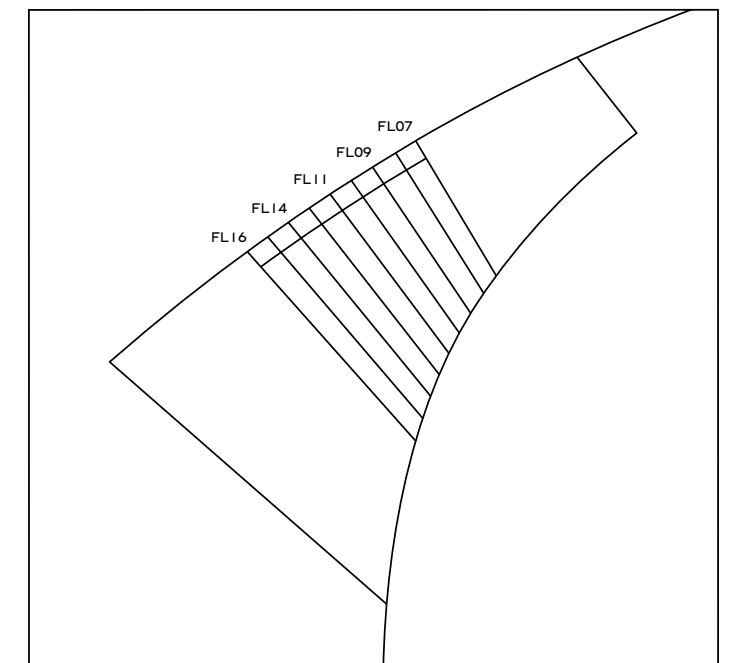
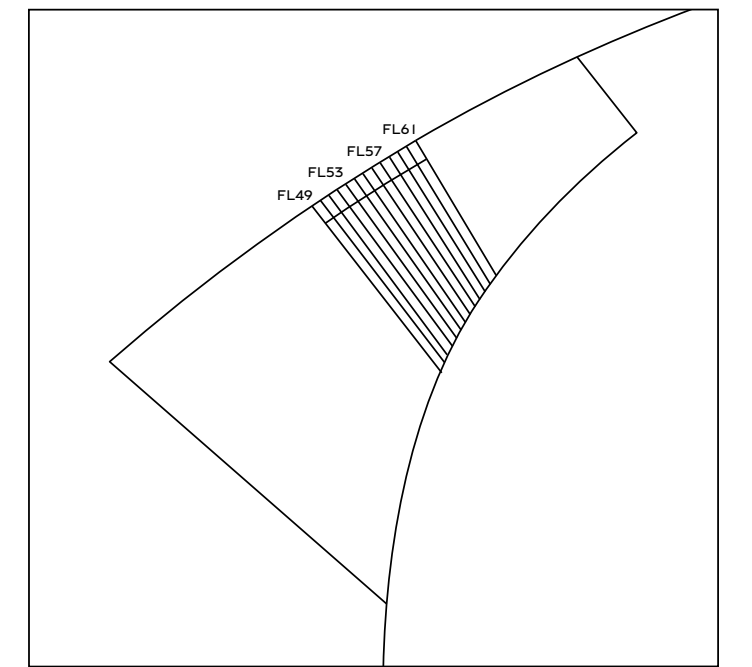

TERRACE AREA VARIES BY FLOOR

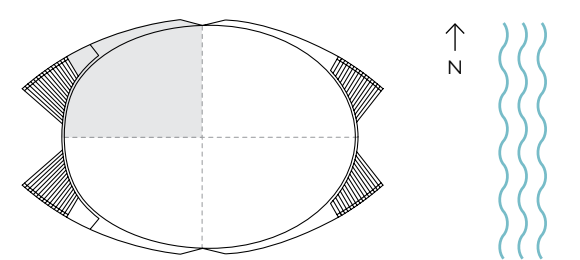

ORAL REPRESENTATIONS CANNOT BE RELIED UPON AS CORRECTLY STATING THE REPRESENTATIONS OF THE DEVELOPER. FOR CORRECT REPRESENTATIONS, MAKE REFERENCE TO THIS BROCHURE AND TO THE DOCUMENTS REQUIRED BY SECTION 718.503, FLORIDA STATUTES, TO BE FURNISHED BY A DEVELOPER TO A BUYER OR LESSEE. Stated dimensions are measured to the exterior boundaries of the exterior walls and the centerline of interior demising walls and in fact vary from the dimensions that would be determined by using the description and definition of the "Unit" set forth in the Declaration (which generally only includes the interior airspace between the perimeter walls and excludes interior structural components). For your reference, the area of the Unit, determined in accordance with those defined unit boundaries, is described on Exhibit 3 to the Declaration. Note that measurements of rooms set forth on this floor plan are generally taken at the greatest points of each given room (as if the room were a perfect rectangle), without regard for any cutouts. Accordingly, the area of the actual room will typically be smaller than the product obtained by multiplying the stated length times width. All dimensions are approximate and may vary with actual construction, and all floor plans and development plans are subject to change. The name 'Bentley' is a registered trademark. © 2022 Bentley Residences.



Sales Gallery: 18325 Collins Avenue, Sunny Isles Beach, FL 33160  
Tel 305 BENTLEY (305 236 8539) [bentleyresidencesmiami.com](http://bentleyresidencesmiami.com)

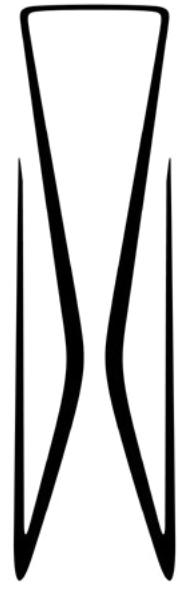

**B**  
BENTLEY  
RESIDENCES

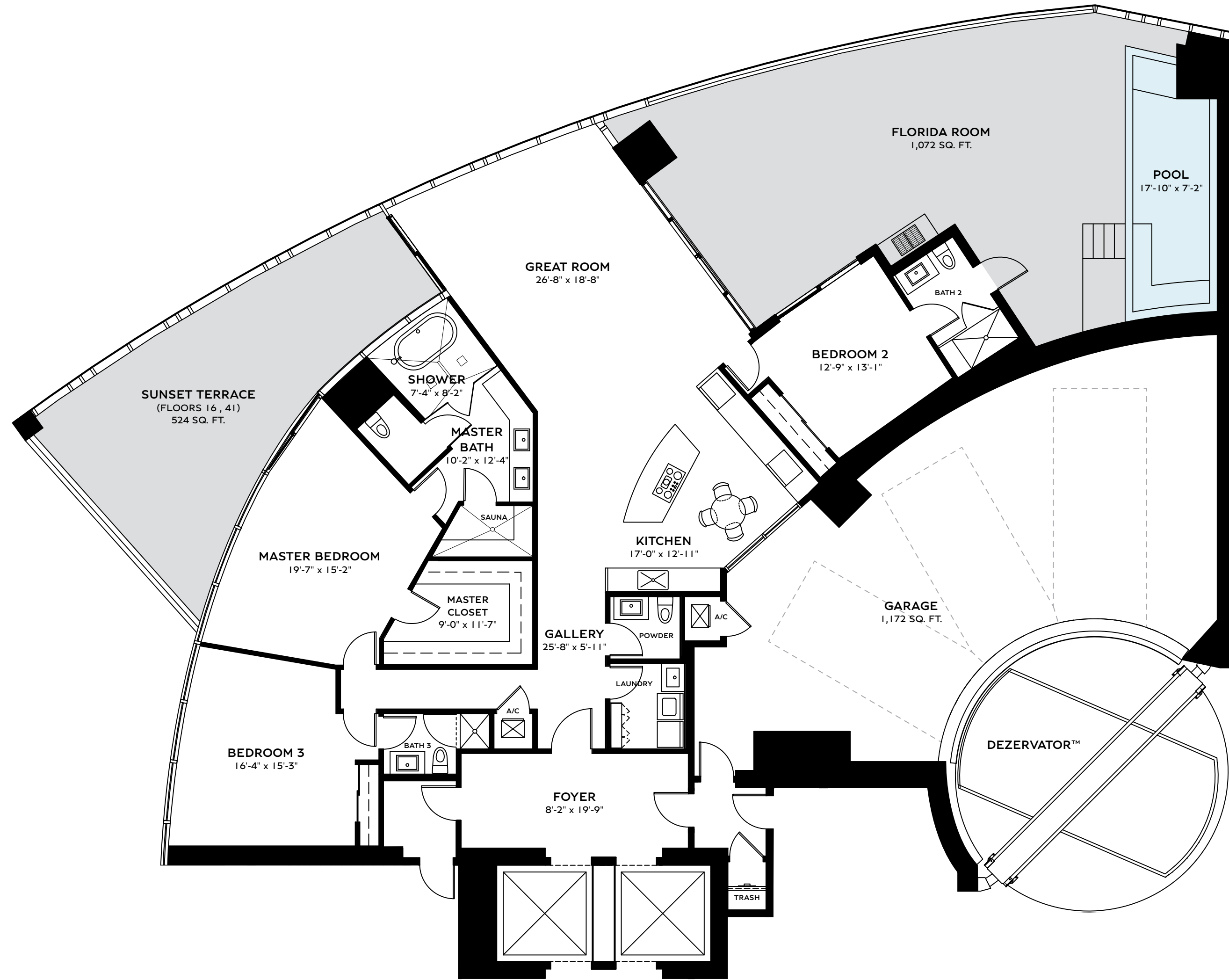

**RESIDENCE BACALAR**  
**3 BEDS | 3.5 BATHS**

FLOORS 16, 41

INTERIOR	2,835 SQ. FT.	263.38 SQ. M.
BALCONY	1,596 SQ. FT.	148.27 SQ. M.
GARAGE	1,172 SQ. FT.	108.88 SQ. M.
<b>TOTAL</b>	<b>5,603 SQ. FT.</b>	<b>520.54 SQ. M.</b>

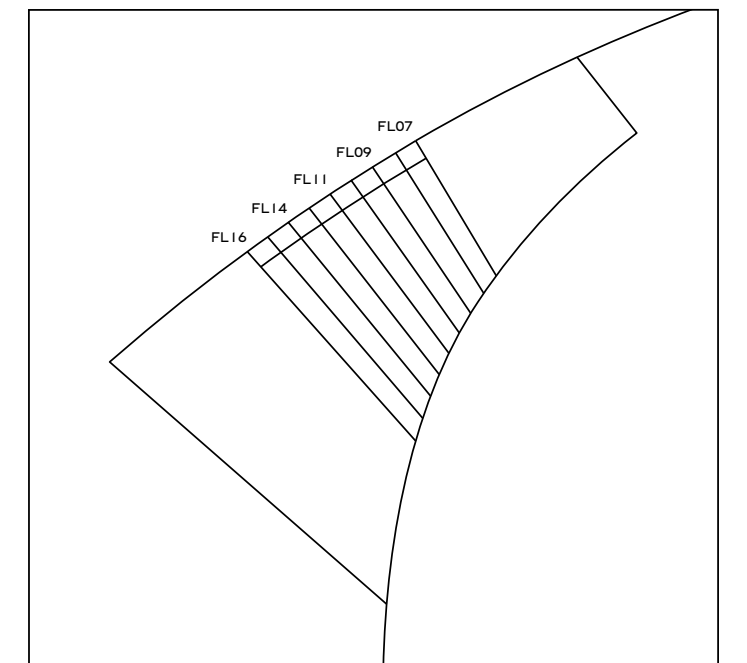
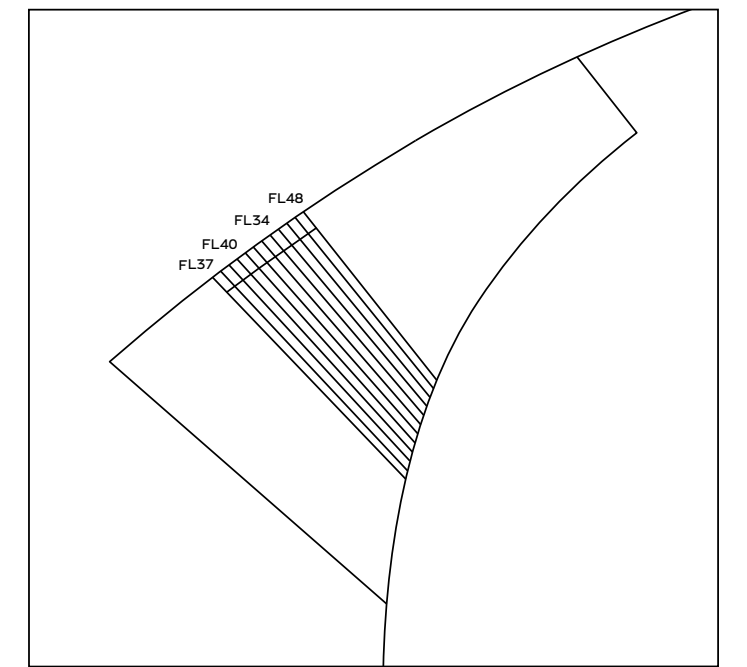

TERRACE AREA VARIES BY FLOOR

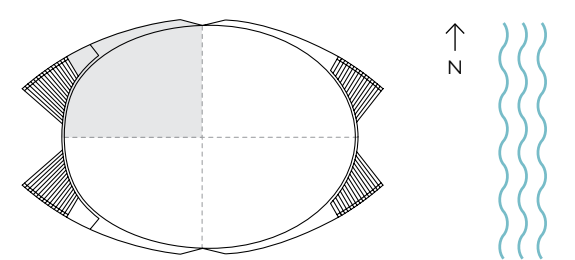

ORAL REPRESENTATIONS CANNOT BE RELIED UPON AS CORRECTLY STATING THE REPRESENTATIONS OF THE DEVELOPER. FOR CORRECT REPRESENTATIONS, MAKE REFERENCE TO THIS BROCHURE AND TO THE DOCUMENTS REQUIRED BY SECTION 718.503, FLORIDA STATUTES, TO BE FURNISHED BY A DEVELOPER TO A BUYER OR LESSEE. Stated dimensions are measured to the exterior boundaries of the exterior walls and the centerline of interior demising walls and in fact vary from the dimensions that would be determined by using the description and definition of the "Unit" set forth in the Declaration (which generally only includes the interior airspace between the perimeter walls and excludes interior structural components). For your reference, the area of the Unit, determined in accordance with those defined unit boundaries, is described on Exhibit 3 to the Declaration. Note that measurements of rooms set forth on this floor plan are generally taken at the greatest points of each given room (as if the room were a perfect rectangle), without regard for any cutouts. Accordingly, the area of the actual room will typically be smaller than the product obtained by multiplying the stated length times width. All dimensions are approximate and may vary with actual construction, and all floor plans and development plans are subject to change. The name 'Bentley' is a registered trademark. © 2022 Bentley Residences.



Sales Gallery: 18325 Collins Avenue, Sunny Isles Beach, FL 33160  
Tel 305 BENTLEY (305 236 8539) [bentleyresidencesmiami.com](http://bentleyresidencesmiami.com)



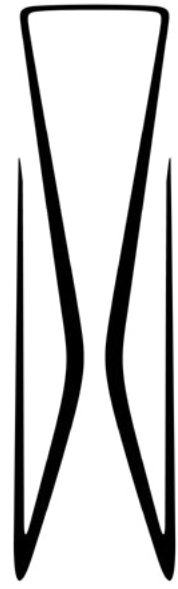

**BENTLEY**  
RESIDENCES

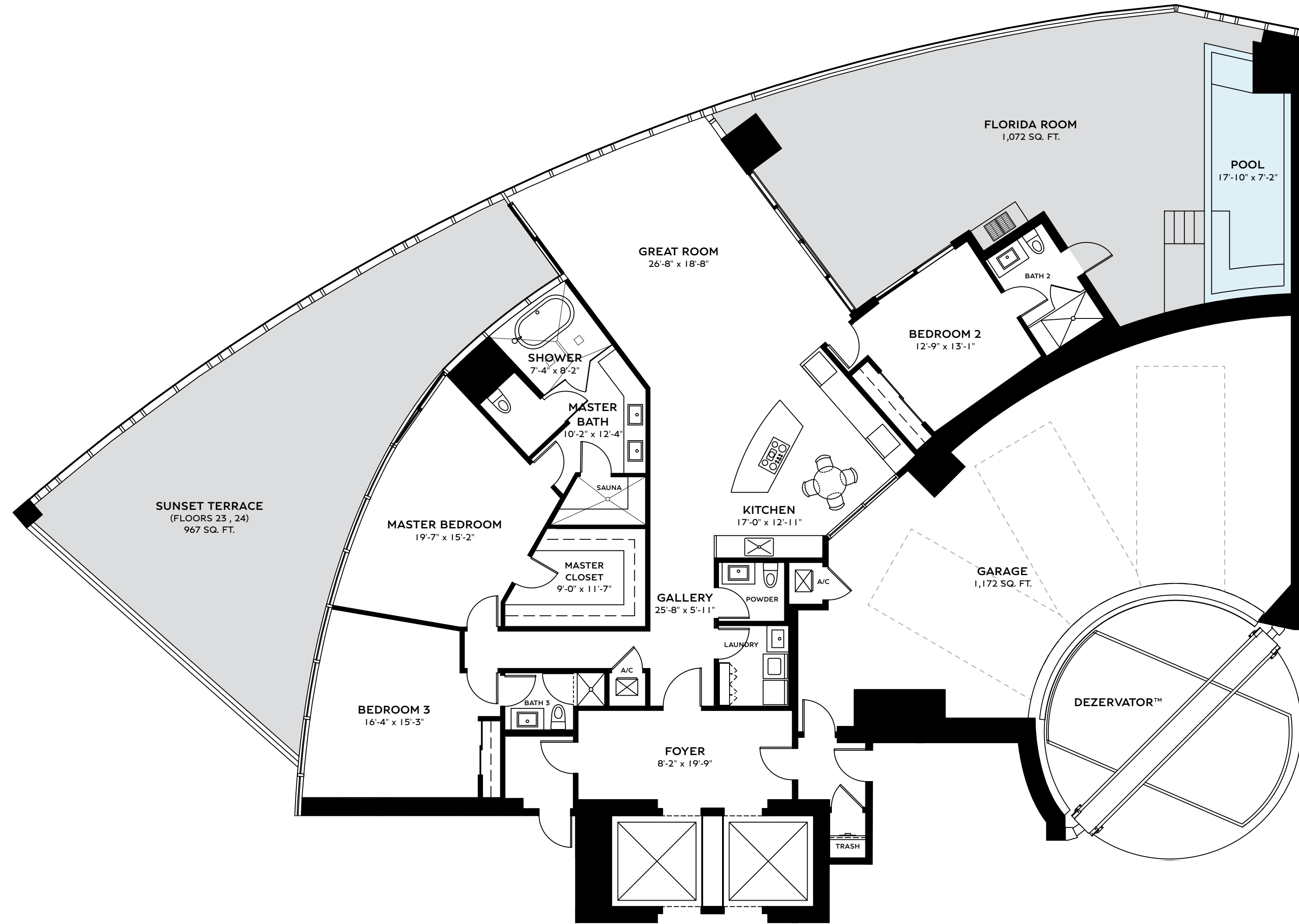

**RESIDENCE BACALAR**  
**3 BEDS | 3.5 BATHS**

FLOORS 23 , 24

INTERIOR	2,835 SQ. FT.	263.38 SQ. M.
BALCONY	2,039 SQ. FT.	189.43 SQ. M.
GARAGE	1,172 SQ. FT.	108.88 SQ. M.
<b>TOTAL</b>	<b>6,046 SQ. FT.</b>	<b>561.69 SQ. M.</b>

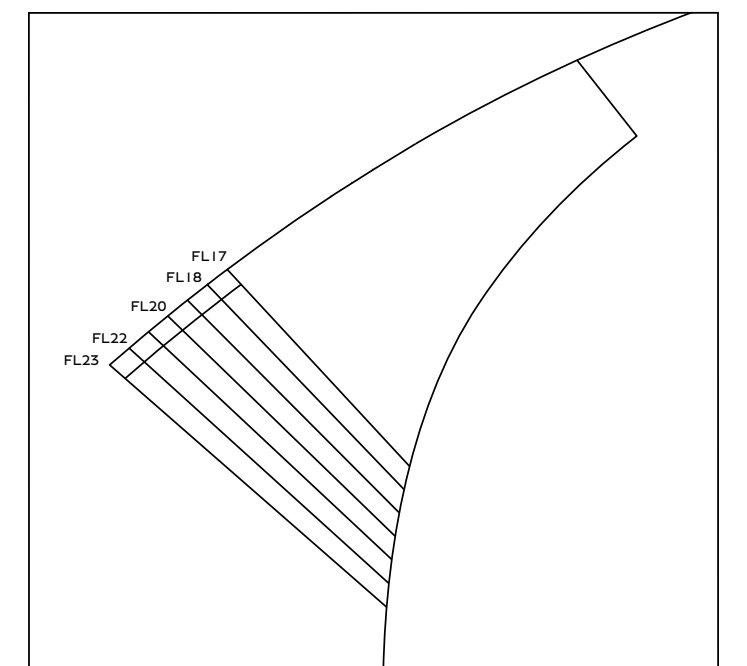
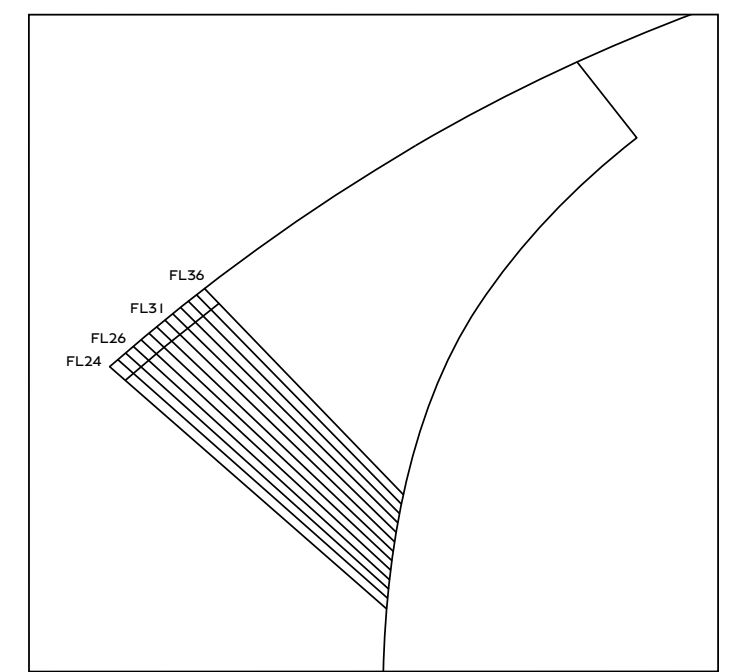

TERRACE AREA VARIES BY FLOOR

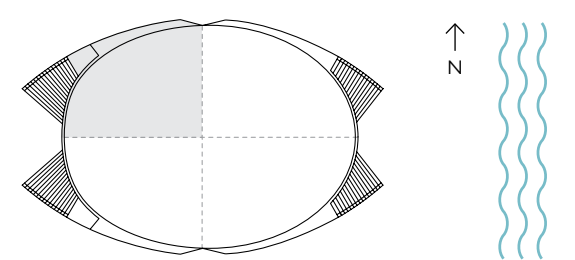

ORAL REPRESENTATIONS CANNOT BE RELIED UPON AS CORRECTLY STATING THE REPRESENTATIONS OF THE DEVELOPER. FOR CORRECT REPRESENTATIONS, MAKE REFERENCE TO THIS BROCHURE AND TO THE DOCUMENTS REQUIRED BY SECTION 718.503, FLORIDA STATUTES, TO BE FURNISHED BY A DEVELOPER TO A BUYER OR LESSEE. Stated dimensions are measured to the exterior boundaries of the exterior walls and the centerline of interior demising walls and in fact vary from the dimensions that would be determined by using the description and definition of the "Unit" set forth in the Declaration (which generally only includes the interior airspace between the perimeter walls and excludes interior structural components). For your reference, the area of the Unit, determined in accordance with those defined unit boundaries, is described on Exhibit 3 to the Declaration. Note that measurements of rooms set forth on this floor plan are generally taken at the greatest points of each given room (as if the room were a perfect rectangle), without regard for any cutouts. Accordingly, the area of the actual room will typically be smaller than the product obtained by multiplying the stated length times width. All dimensions are approximate and may vary with actual construction, and all floor plans and development plans are subject to change. The name 'Bentley' is a registered trademark. © 2022 Bentley Residences.



Sales Gallery: 18325 Collins Avenue, Sunny Isles Beach, FL 33160  
Tel 305 BENTLEY (305 236 8539) [bentleyresidencesmiami.com](http://bentleyresidencesmiami.com)

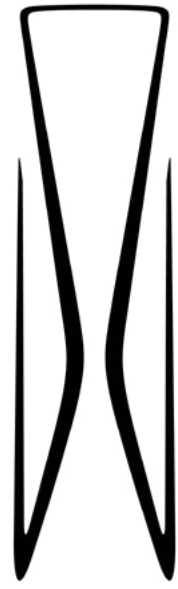

**B**  
BENTLEY  
RESIDENCES

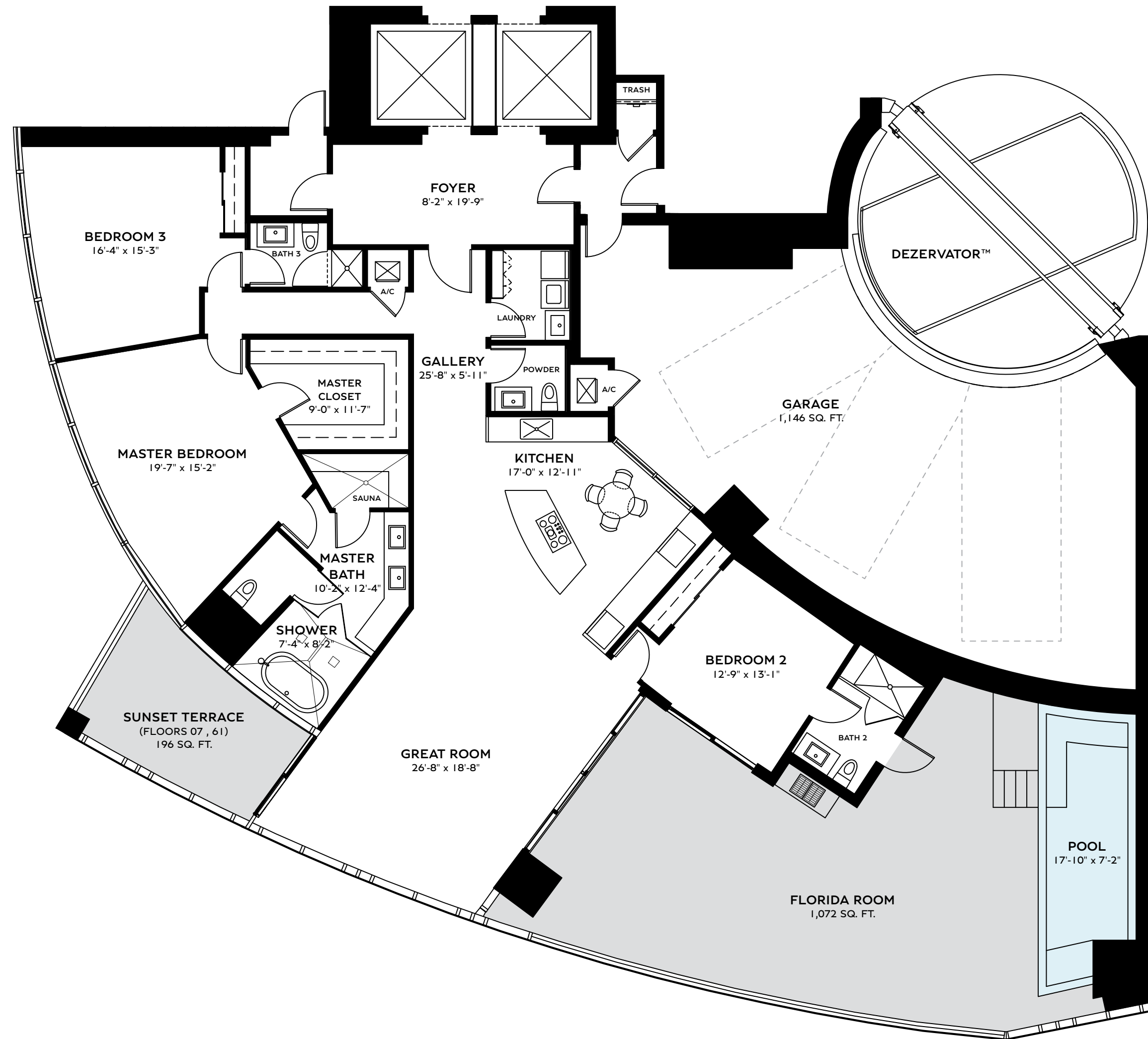

**RESIDENCE BENTAYGA**  
**3 BEDS | 3.5 BATHS**

FLOORS 07 , 61

INTERIOR	2,835 SQ. FT.	263.38 SQ. M.
BALCONY	1,268 SQ. FT.	117.80 SQ. M.
GARAGE	1,146 SQ. FT.	106.47 SQ. M.
<b>TOTAL</b>	<b>5,249 SQ. FT.</b>	<b>487.65 SQ. M.</b>

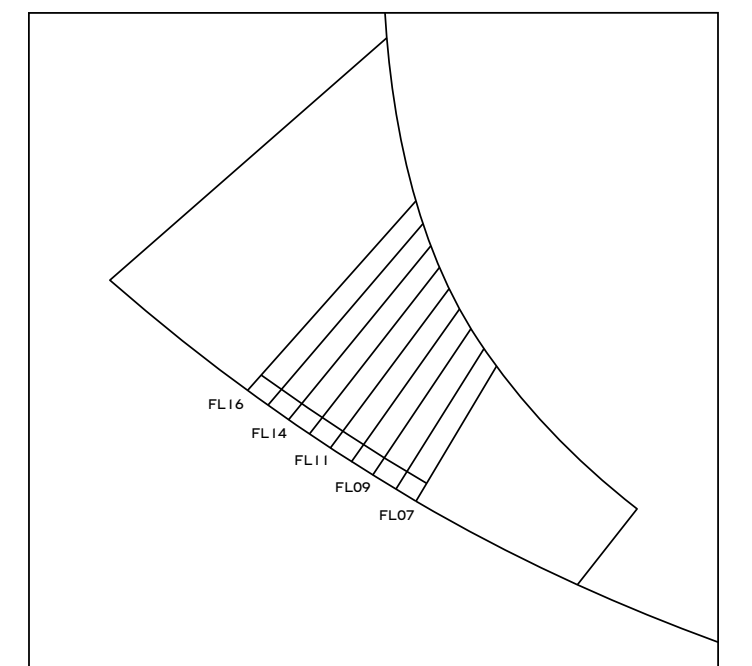
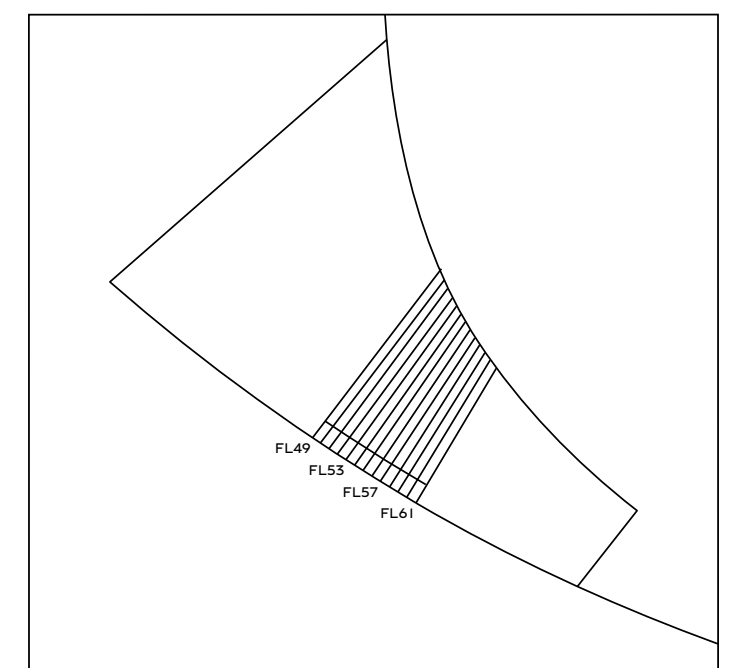

TERRACE AREA VARIES BY FLOOR

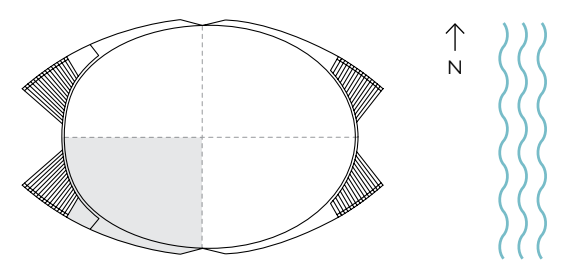

ORAL REPRESENTATIONS CANNOT BE RELIED UPON AS CORRECTLY STATING THE REPRESENTATIONS OF THE DEVELOPER. FOR CORRECT REPRESENTATIONS, MAKE REFERENCE TO THIS BROCHURE AND TO THE DOCUMENTS REQUIRED BY SECTION 718.503, FLORIDA STATUTES, TO BE FURNISHED BY A DEVELOPER TO A BUYER OR LESSEE. Stated dimensions are measured to the exterior boundaries of the exterior walls and the centerline of interior demising walls and in fact vary from the dimensions that would be determined by using the description and definition of the "Unit" set forth in the Declaration (which generally only includes the interior airspace between the perimeter walls and excludes interior structural components). For your reference, the area of the Unit, determined in accordance with those defined unit boundaries, is described on Exhibit 3 to the Declaration. Note that measurements of rooms set forth on this floor plan are generally taken at the greatest points of each given room (as if the room were a perfect rectangle), without regard for any cutouts. Accordingly, the area of the actual room will typically be smaller than the product obtained by multiplying the stated length times width. All dimensions are approximate and may vary with actual construction, and all floor plans and development plans are subject to change. The name 'Bentley' is a registered trademark. © 2022 Bentley Residences.



Sales Gallery: 18325 Collins Avenue, Sunny Isles Beach, FL 33160  
Tel 305 BENTLEY (305 236 8539) [bentleyresidencesmiami.com](http://bentleyresidencesmiami.com)

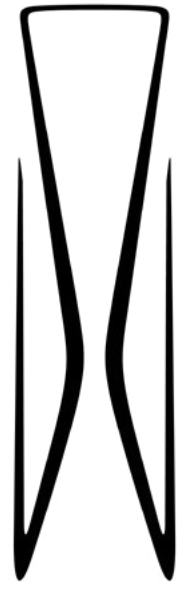

**B**  
BENTLEY  
RESIDENCES

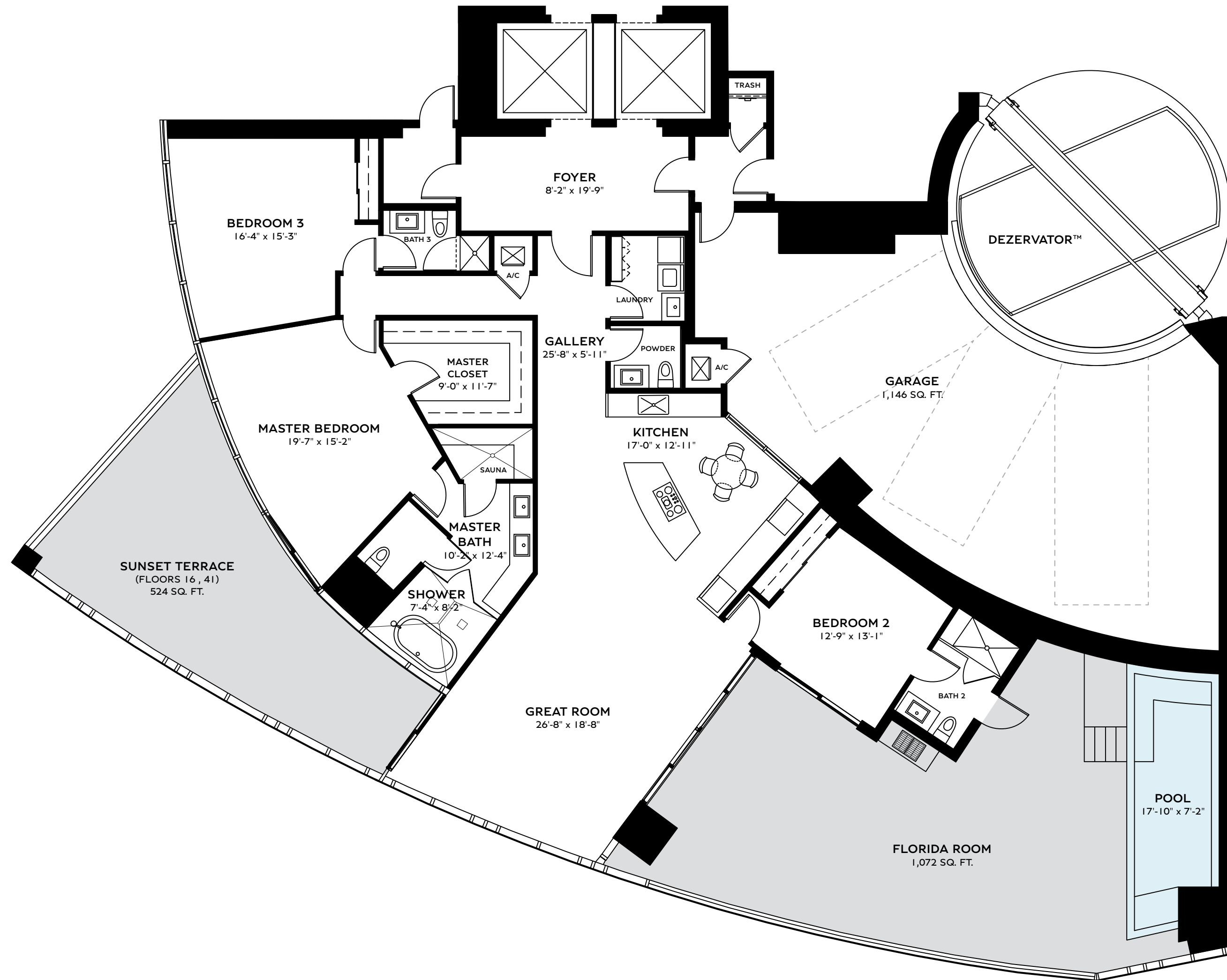

**RESIDENCE BENTAYGA**  
**3 BEDS | 3.5 BATHS**  
FLOORS 16, 41

INTERIOR	2,835 SQ. FT.	263.38 SQ. M.
BALCONY	1,596 SQ. FT.	148.27 SQ. M.
GARAGE	1,146 SQ. FT.	106.47 SQ. M.
<b>TOTAL</b>	<b>5,577 SQ. FT.</b>	<b>518.12 SQ. M.</b>

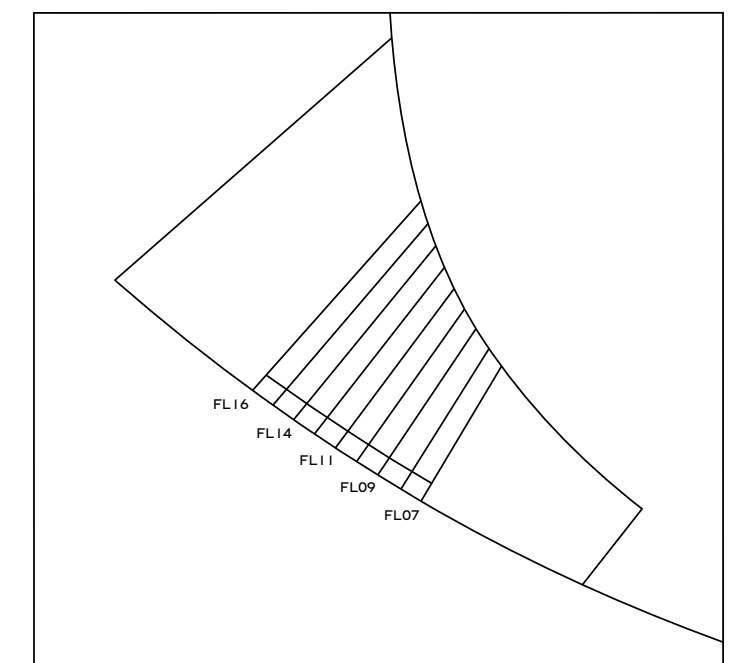
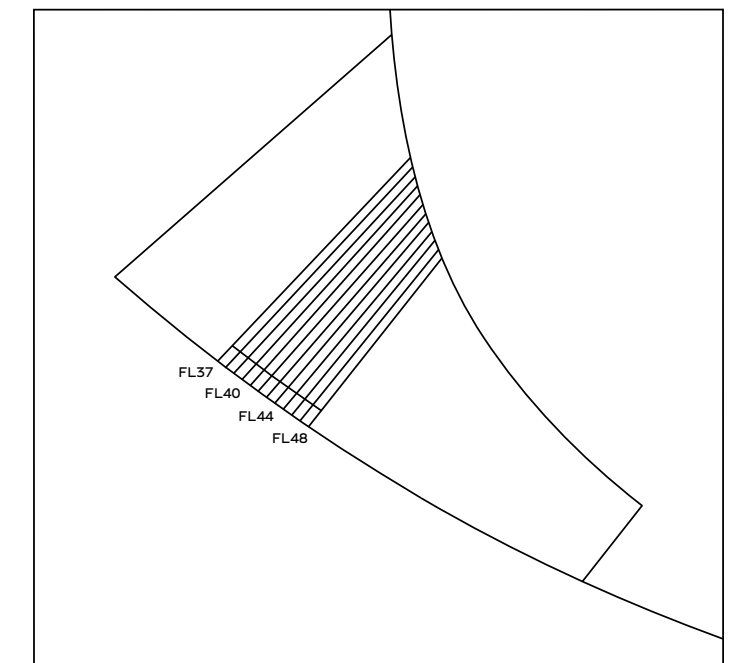

TERRACE AREA VARIES BY FLOOR

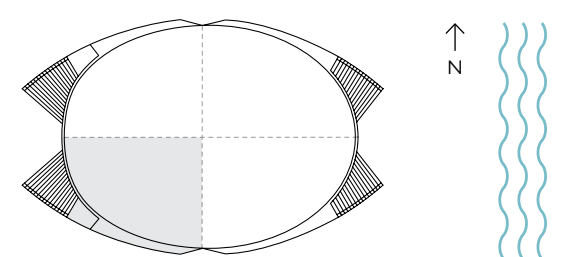

ORAL REPRESENTATIONS CANNOT BE RELIED UPON AS CORRECTLY STATING THE REPRESENTATIONS OF THE DEVELOPER. FOR CORRECT REPRESENTATIONS, MAKE REFERENCE TO THIS BROCHURE AND TO THE DOCUMENTS REQUIRED BY SECTION 718.503, FLORIDA STATUTES, TO BE FURNISHED BY A DEVELOPER TO A BUYER OR LESSEE. Stated dimensions are measured to the exterior boundaries of the exterior walls and the centerline of interior demising walls and in fact vary from the dimensions that would be determined by using the description and definition of the "Unit" set forth in the Declaration (which generally only includes the interior airspace between the perimeter walls and excludes interior structural components). For your reference, the area of the Unit, determined in accordance with those defined unit boundaries, is described on Exhibit 3 to the Declaration. Note that measurements of rooms set forth on this floor plan are generally taken at the greatest points of each given room (as if the room were a perfect rectangle), without regard for any cutouts. Accordingly, the area of the actual room will typically be smaller than the product obtained by multiplying the stated length times width. All dimensions are approximate and may vary with actual construction, and all floor plans and development plans are subject to change. The name 'Bentley' is a registered trademark. © 2022 Bentley Residences.



Sales Gallery: 18325 Collins Avenue, Sunny Isles Beach, FL 33160  
Tel 305 BENTLEY (305 236 8539) [bentleyresidencesmiami.com](http://bentleyresidencesmiami.com)

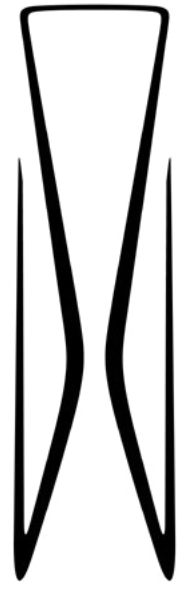

**B**  
BENTLEY  
RESIDENCES

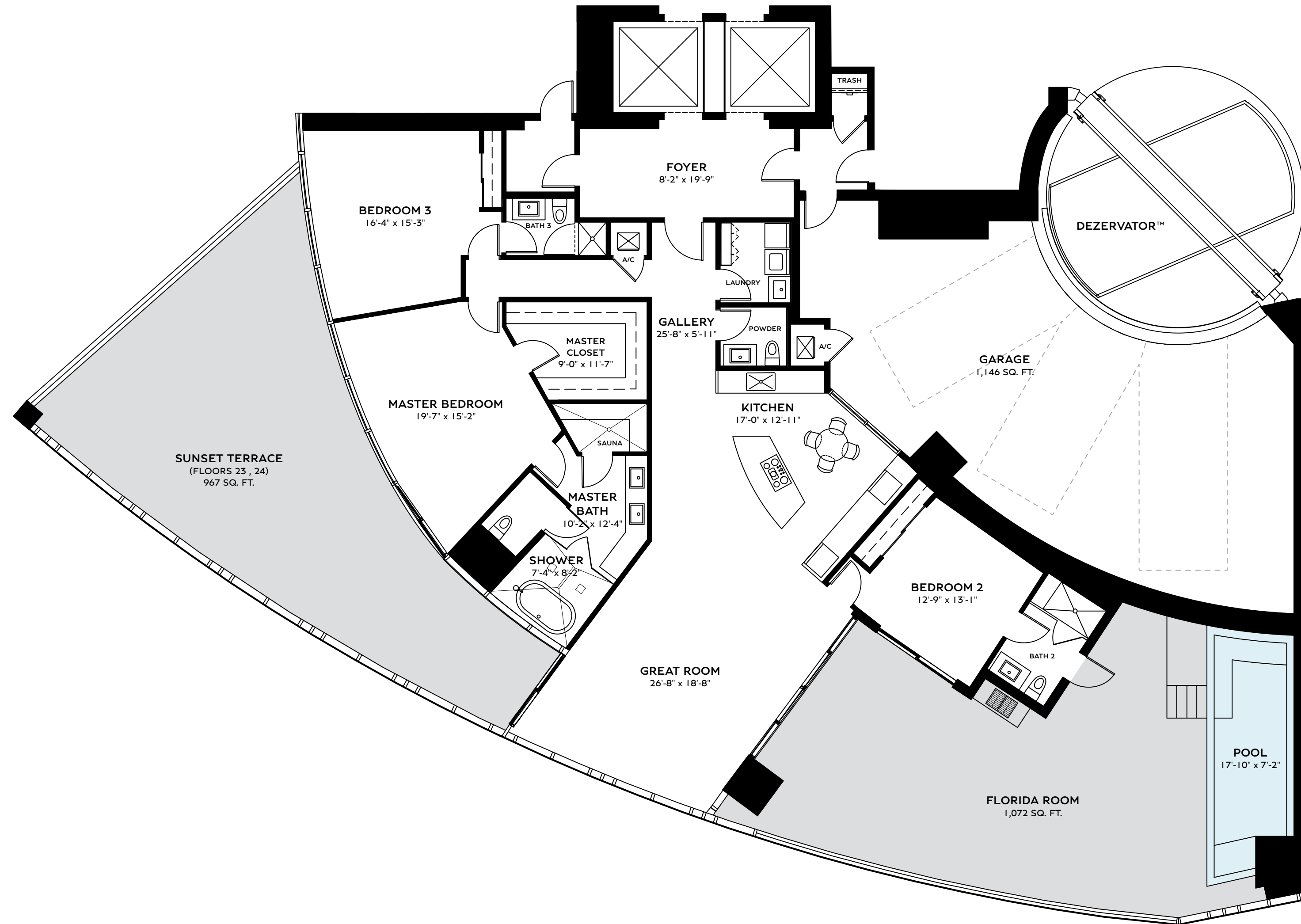

**RESIDENCE BENTAYGA**  
**3 BEDS | 3.5 BATHS**  
FLOORS 23 , 24

INTERIOR	2,835 SQ. FT.	263.38 SQ. M.
BALCONY	2,039 SQ. FT.	189.43 SQ. M.
GARAGE	1,146 SQ. FT.	106.47 SQ. M.
<b>TOTAL</b>	<b>6,020 SQ. FT.</b>	<b>559.28 SQ. M.</b>

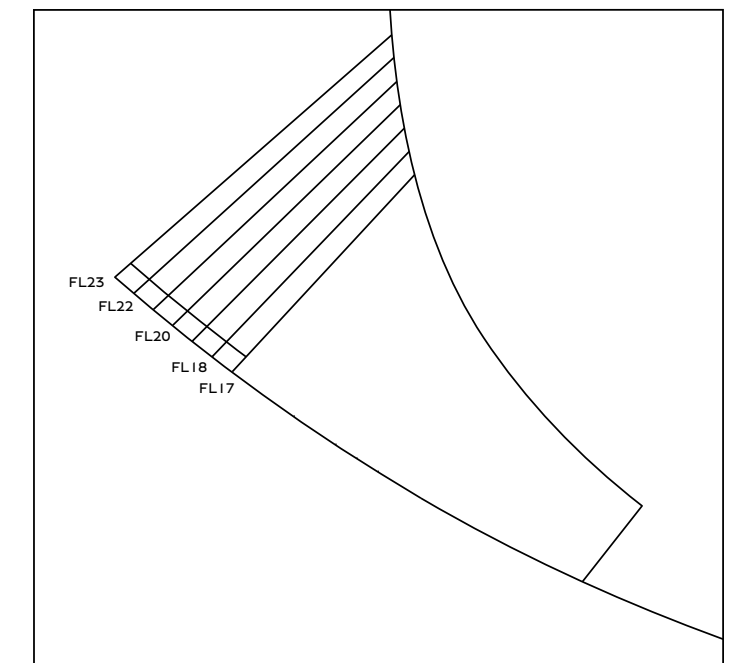
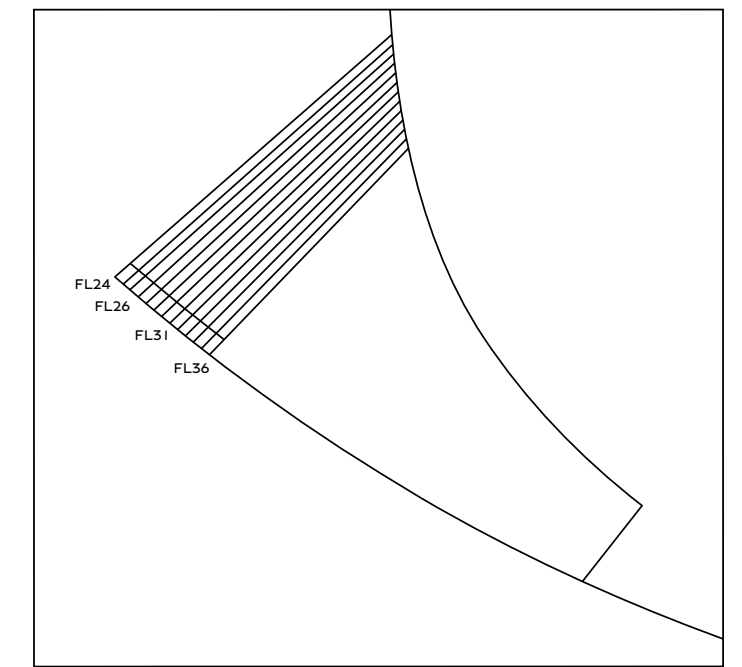

TERRACE AREA VARIES BY FLOOR

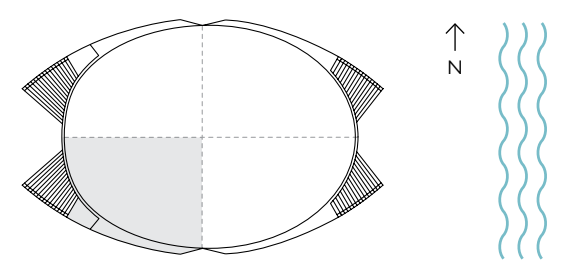

ORAL REPRESENTATIONS CANNOT BE RELIED UPON AS CORRECTLY STATING THE REPRESENTATIONS OF THE DEVELOPER. FOR CORRECT REPRESENTATIONS, MAKE REFERENCE TO THIS BROCHURE AND TO THE DOCUMENTS REQUIRED BY SECTION 718.503, FLORIDA STATUTES, TO BE FURNISHED BY A DEVELOPER TO A BUYER OR LESSEE. Stated dimensions are measured to the exterior boundaries of the exterior walls and the centerline of interior demising walls and in fact vary from the dimensions that would be determined by using the description and definition of the "Unit" set forth in the Declaration (which generally only includes the interior airspace between the perimeter walls and excludes interior structural components). For your reference, the area of the Unit, determined in accordance with those defined unit boundaries, is described on Exhibit 3 to the Declaration. Note that measurements of rooms set forth on this floor plan are generally taken at the greatest points of each given room (as if the room were a perfect rectangle), without regard for any cutouts. Accordingly, the area of the actual room will typically be smaller than the product obtained by multiplying the stated length times width. All dimensions are approximate and may vary with actual construction, and all floor plans and development plans are subject to change. The name 'Bentley' is a registered trademark. © 2022 Bentley Residences.



Sales Gallery: 18325 Collins Avenue, Sunny Isles Beach, FL 33160  
Tel 305 BENTLEY (305 236 8539) [bentleyresidencesmiami.com](http://bentleyresidencesmiami.com)